

Thank you for choosing Springs Window Fashions. Your shade has been custom-sized based on your specifications with the highest standards of quality and craftsmanship.

Follow the easy step-by-step instructions to install your shade. Should you need additional support, please feel free to call our Customer Service Center at 1-800-221-6352 or email us at windowfashions@springswindowfashions.com. We will be glad to help you.

For additional safety information in Canada, contact 1-866-662-0666.

Gracias por elegir Springs Window Fashions. Su persiana se ha confeccionado a la medida según sus especificaciones y con los estándares más altos de calidad y fabricación.

Siga las sencillas instrucciones detalladas para instalar su persiana. Si necesita asistencia adicional, comuníquese con nuestro Centro de servicio al cliente al 1-800-221-6352 o por correo electrónico a windowfashions@springswindowfashions.com. Será un gusto poder ayudarlo.

Para información adicional en Canadá sobre seguridad, llamar al 1-866-662-0666.

Merci d'avoir choisi Springs Window Fashions. Votre store a été taillé sur mesure selon vos spécifications avec les normes les plus élevées de qualité et de fabrication.

Suivez les directives étape par étape faciles pour installer votre store. Si vous avez besoin d'aide supplémentaire, n'hésitez pas à communiquer avec notre centre de service à la clientèle au 1-800-221-6352 ou envoyez-nous un courriel à windowfashions@springswindowfashions.com. Nous serons heureux de vous aider.

Pour de plus amples informations sur la sécurité au Canada, appelez le 1-866-662-0666.

HOW TO INSTALL CÓMO INSTALAR COMMENT INSTALLER

How to install inside-, outside- or ceiling-mount 2" aluminum and vinyl blinds

Como instalar las persianas horizontales de aluminio e imitación madera de 5 cm de montaje empotrado, exterior y superior

Comment installer les stores de 5 cm en aluminium et en vinyle à l'intérieur, à l'extérieur et au plafond

1 Everything needed to install your blind Todo lo necesario para instalar la persiana Tout ce qu'il faut pour la pose du store

Optional • Opcional • Facultatif

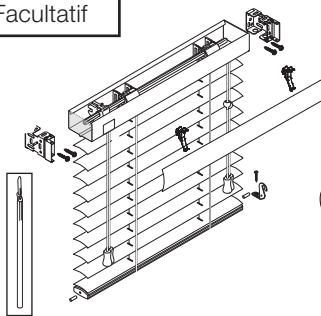
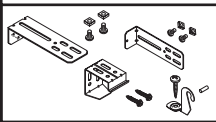

Tools needed
Herramientas necesarias
Outillage nécessaire

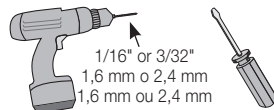

1/16" or 3/32"
1,6 mm o 2,4 mm
1,6 mm ou 2,4 mm

2 Mark bracket location Marque el lugar de la ménsula Marquez la position du support

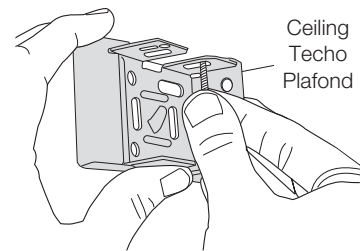

Ceiling
Techo
Plafond

OR
•
O
•
OU

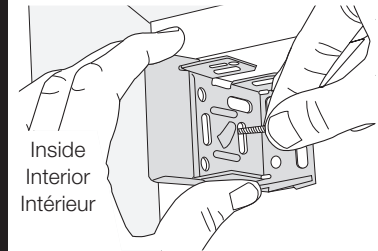

Inside
Interior
Intérieur

OR • O • OU

Outside
Exterior
Extérieur

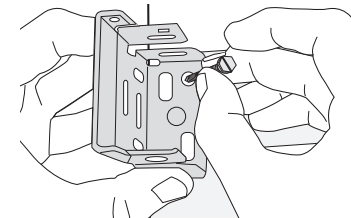

2" Aluminum Blinds 2" Vinyl Blinds with 1 or 2 Stat Valance

Valance Widths:	Valance Clips
up to 36" use	2 clips
up to 62" use	3 clips
up to 88" use	4 clips
up to 114" use	5 clips
up to 140" use	6 clips
over 140" use	7 clips

All Blinds

Headrail Widths: Center Support Brackets	use
up to 48"	0
up to 72"	1
up to 96"	2
up to 120"	3
up to 144"	4

Persianas horizontales de aluminio 5 cm Persianas imitación madera de 5 cm con 1 ó 2 Cenefas de Tablilla

Anchos de Cenefa:	use	Sujetadores de Cenefa
hasta 91,4 cm	2	2 sujetadores
hasta 157,5 cm	3	3 sujetadores
hasta 223,5 cm	4	4 sujetadores
hasta 289,6 cm	5	5 sujetadores
hasta 355,6 cm	6	6 sujetadores
mas de 355,6 cm	7	7 sujetadores

Todas las Persianas

Anchos de Cabezales:	use	Soportes de Sostén Central
hasta 121,9 cm	0	0
hasta 182,9 cm	1	1
hasta 243,8 cm	2	2
hasta 304,8 cm	3	3
hasta 365,8 cm	4	4

Stores en aluminium de 5 cm Stores en vinyle de 5 cm avec cantonnières à 1 ou 2 lattes

Largues des cantonnières :	use	Agrafes de cantonnière
Jusqu'à 91,4 cm	2	2 agrafes
Jusqu'à 157,5 cm	3	3 agrafes
Jusqu'à 223,5 cm	4	4 agrafes
Jusqu'à 289,6 cm	5	5 agrafes
Jusqu'à 355,6 cm	6	6 agrafes
Supérieure à 355,6 cm	7	7 agrafes

Tous les stores

Largues des boîtiers :	utiliser	Supports de soutien central
Jusqu'à 121,9 cm	0	0
Jusqu'à 182,9 cm	1	1
Jusqu'à 243,8 cm	2	2
Jusqu'à 304,8 cm	3	3
Jusqu'à 365,8 cm	4	4

2

Optional center support(s)/projection brackets Opcional soporte central/soportes de extensión Facultatif supports du centre/supports de projection

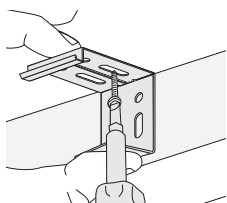

Position the center support(s) in line with the mounting brackets so they will not interfere with the ladder tapes. Space evenly and keep out of the way of other working parts.

Ponga el soporte central en línea con las ménsulas de instalación de modo que no interfieran con las cintas de escalerillas. Ponga a espacios iguales y alejado de las piezas operacionales.

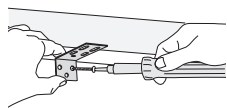

Placer les supports du centre dans le prolongement des supports de montage de manière à ne pas gêner l'échelle de support des lamelles. Placez-les à intervalles réguliers et hors de contact avec toute pièce mobile.

2

Optional center support(s)/projection brackets Opcional soporte central/soportes de extensión Facultatif supports du centre/supports de projection

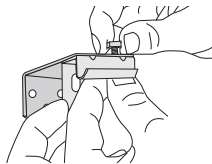
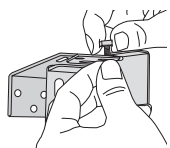
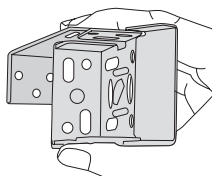

3

Drill holes Perfore agujeros Percez des trous

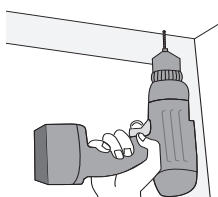

Ceiling
Techo
Plafond

OR
•
O
•
OU

Outside
Exterior
Extérieur

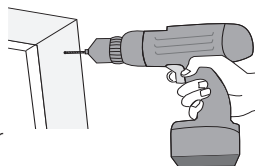

4

Screw in brackets Atornille las ménsulas Vissez les supports

Ceiling
Techo
Plafond

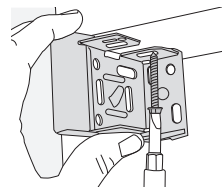

OR
•
O
•
OU

Inside
Interior
Intérieur

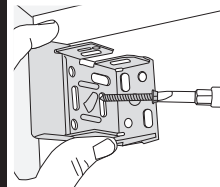

OR
•
O
•
OU

Outside
Exterior
Extérieur

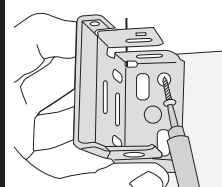

5

Mount blind in brackets Instale la persiana en las ménsulas Fixez le store dans les supports

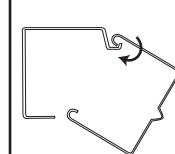
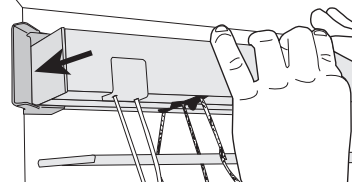

Place rail front lip on center support. Roll rail back into brackets

Coloque el borde delantero del riel en el soporte central. Retroceda el riel en los soportes.

Placez la lèvre avant du rail sur le support central. Roulez le rail vers l'arrière dans les supports.

6

Attach valance clip Ponga el sujetador de cenefa Fixez l'attache de cantonnière

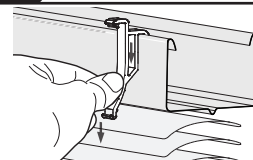

OR
•
O
•
OU

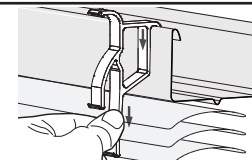

7

Close door on brackets Cierre la puerta en las ménsulas Fermez la porte des supports

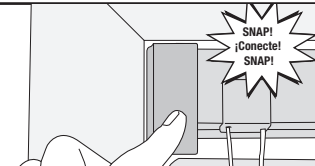
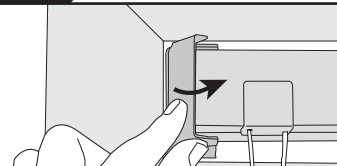

SNAP!
¡Conecte!
SNAP!

8

Optional valance with returns Opcional faja decorativa con retornos Facultatif cantonnière avec retours

2" Vinyl • Persianas de vinil de 5.1 cm • Stores en vinyle de 5,1 cm

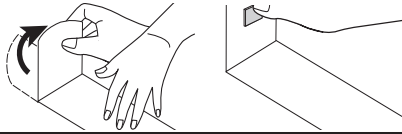

OR
•
O
•
OU

2" Aluminum • Persianas de aluminio de 5.1 cm • Stores en aluminium de 5,1 cm

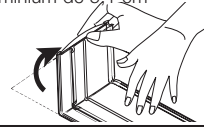

8

Attach valance Ponga la cenefa Fixez la cantonnière

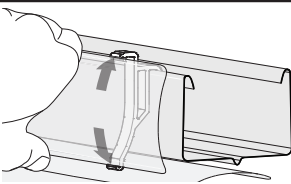

OR
•
O
•
OU

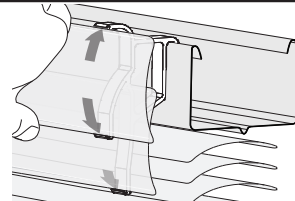

9

Optional hold-down brackets Opcional soportes sostenedores Facultatif supports de retenue

Break hold-down brackets apart using pliers.
Usando unas pinzas, doble el sujetador de los soportes.
Détacher les retenues de supports à l'aide de pince.

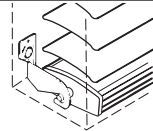
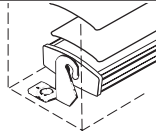
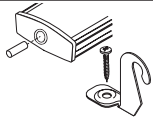
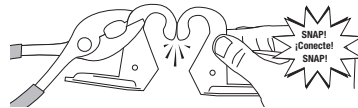

10

Attach tilt wand (optional) Fijación de la varilla (opcional) Fixation de la baguette d'inclinaison (en option)

1

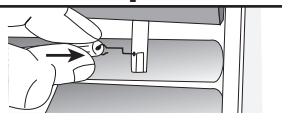

2



3

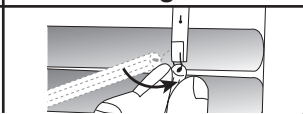

11

Install cord cleat (optional) Instale la abrazadera para cordón (opcional) Fixez le taquet à cordon (en option)

Install cord cleats 6" to 12" apart at a height out of reach of children. Wrap cords around cleats when not in use.

Instale los cordones antideslizantes separados de 15,2 cm a 30 cm, a una altura lejos del alcance de los niños. Envuelva los cordones alrededor del listón cuando no estén en uso.

Installez les taquets pour cordon à une distance de 15,2 à 30,5 cm l'un de l'autre à une hauteur qui est hors de la portée des enfants.

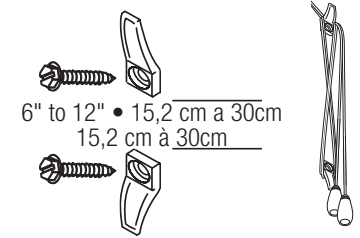

Cleaning instructions Instrucciones para la limpieza Directives de nettoyage

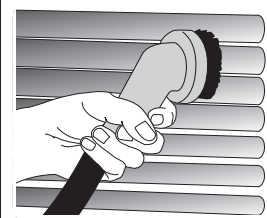
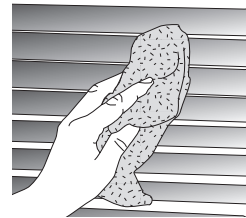

Use warm water and mild non-abrasive liquid soap.
Use agua caliente y jabón líquido suave no raspante.
Utilisez de l'eau tiède et un savon doux liquide non abrasif.



Blind operation Funcionamiento de la persiana Fonctionnement du store

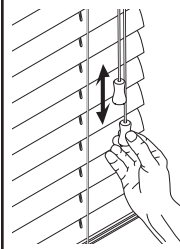

To tilt the slats open or closed, simply pull on the tilt cord.

Para inclinar los listones para abrir o cerrar, simplemente tire del cordón de inclinación.

Pour incliner les lattes en position ouverte ou fermée, tirez simplement sur le cordon d'inclinaison.

To raise or lower the blind, simply pull on the lift cord.

Para levantar o bajar la persiana, simplemente tire del cordón de elevación.

Pour relever ou abaisser le store, tirez simplement sur le cordon de levage.

