

Measuring Guide for Roman Shades

Tools and Tips

- **Steel tape measure** — do not use cloth tape
- **Pencil**
- **Measurement Worksheet** – See page 3
- **Measure each window** and identify window locations – size variances are common
- **Round measurements** to the nearest 1/8"
- **Clearly record measurements** – width vs. height

Double-check your work—always measure twice to ensure accuracy.

1/8"
1/4"
3/8"
1/2"
5/8"
3/4"
7/8"

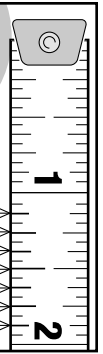

Choose a Mount Type: Inside Mount or Outside Mount

(See next page if you need help deciding which mount is best for your windows.)

Inside Mount Window treatments are installed inside the window casing.

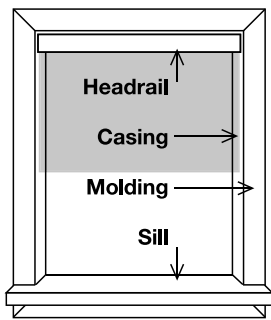

Inside Mount Blind

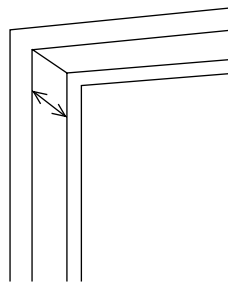

Depth

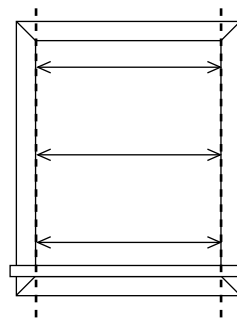

Width

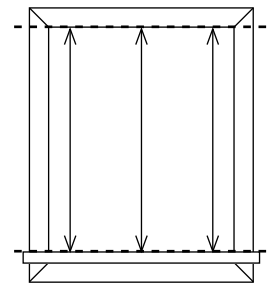

Height

- ➊ **Measure Depth:** See the chart on next page to determine if window casing has enough depth for an inside-mount window treatment.
- ➋ **Measure Width:** Measure the inside width of window casing in three places. Record narrowest measurement.
- ➌ **Measure Height:** Measure the inside height from the top of window casing to top of sill in three places. Record longest measurement.

Note: Do not take any deductions for clearance. The manufacturer will take a 3/8" deduction off the overall width for a perfect fit.

Outside Mount Window treatments are installed outside the window casing. Mount directly to wall or molding.

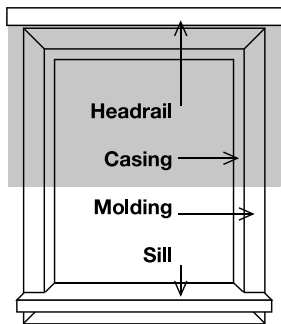

Outside Mount Blind

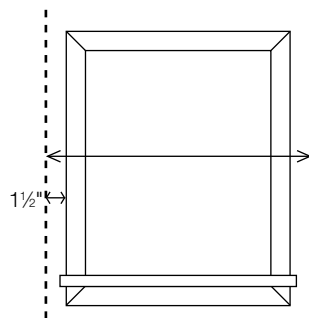

Width

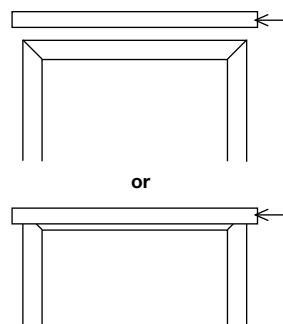

Headrail Location

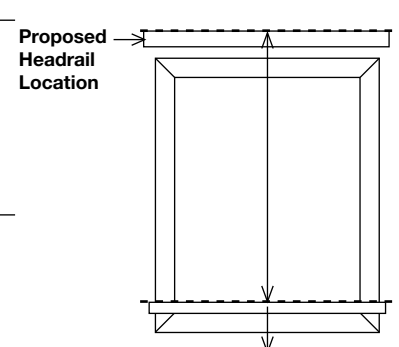

Height

- ➊ **Measure Width:** Measure width to be covered. We recommend 1 1/2" overlap on each side of the window (3" total) for optimum light control and privacy. Record measurement.
- ➋ **Determine Headrail Location** Determine if headrail will be on molding or above molding and mark spot.
- ➌ **Measure Height:** Measure height to be covered from top of headrail location to top of sill or lower if overlap is desired for additional light control and privacy. Record measurement.

Note: The manufacturer makes NO deductions on outside-mount installations.

Mounting Considerations

Reason for Choosing Inside Mount

Clean Look

- Inside-mount treatments are installed inside the window casing, showcasing attractive window trim.
- The window opening frames the treatment for a finished, clean appearance.

Allows Sill Space on Deep Windows

- In some deep-set windows, the window treatment can be installed to allow plants or other items to be placed in front of the window treatment on the sill.

Limitations of Inside Mount

Light Gaps

- A small deduction in the width is taken at the manufacturer to allow for proper operating clearance, and this causes a small gap on each side of the treatment, affecting the treatment's ability to darken a room.

Obstructed View

- The stack (compressed portion of the window treatment when fully raised) will obstruct a part of the view from the window.
- The amount of stack varies by product.

Architectural Obstacles

- Obstacles such as handles and cranks can interfere with the operation of inside-mount treatments.

Reason for Choosing Outside Mount

Improve Privacy and Light Control

- Light gaps on the side of the window treatment can be substantially diminished or eliminated.

Fewer Installation Limitations

- Outside-mount window treatments are ideal for covering non-square windows.
- Outside-mount window treatments are installed higher than the window opening for an unobstructed view when fully raised.

Architectural Obstacles

- Outside-mount window treatments can clear obstacles like handles and cranks.

Enlarge the Look of a Small Window

- Increase overlap above and below or to each side of the window.

Hide Window Trim

- Outside-mount treatments can easily hide unattractive window trim.

Limitations of Outside Mount

Required Surface Above Window Frame

- Outside-mount brackets require at least 2" of flat surface above window or on window frame for mounting brackets; Projection brackets or shims can be ordered if needed to clear frame or molding.

Inside Mount Window Casing Minimum Depth Requirements

A. Flush Mount: If the window casing is deep enough to mount the entire headrail and fabric inside of it, this is called a flush mount.

B. Partially Recessed: A partially recessed window treatment is when the depth of the window casing is less than the space necessary for a flush mount.



Depth needed for Flush Mount

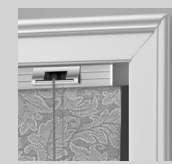

Depth needed for Partially Recessed

Roman Shades Control Type	Fabric Style	Depth needed for Flush Mount	Depth needed for Partially Recessed
Standard Cord Lift	Looped	4 ⁷ / ₈ "	3/4"
	Flat	1 ⁷ / ₈ "	
Continuous-loop Lift	Looped	5 ¹ / ₈ "	
	Flat	2 ¹ / ₈ "	
Bottom Up/Top Down	Looped	4 ⁷ / ₈ "	
	Flat	1 ⁷ / ₈ "	

Flush mount includes headrail and fabric and is approximate. This can vary by fabric.

Measuring and Ordering Worksheet

Window #1 _____
(location)

Measuring

For Inside Mount

Depth of window casing: _____

Measure width of window in 3 places
and circle the narrowest width below:

Width #1: _____

Width #2: _____

Width #3: _____

Measure height of window in 3 places
and circle the longest height below:

Height #1: _____

Height #2: _____

Height #3: _____

For Outside Mount

Width: _____

Height: _____

Ordering

Mount Type: Inside Outside

Ordering Width: _____

Ordering Height: _____

Type of Blind or Shade: _____

Style Name: _____

Color Number: _____

Controls & Options to consider:

Corded

Cordless

Bottom Up/Top Down
(Cellular, Pleated, Roman, and
Natural Shades)

Sun Up/Sun Down
(Cellular & Pleated Shades only)

Cornice: _____

Valance: _____

Other: _____

Window #2 _____
(location)

Measuring

For Inside Mount

Depth of window casing: _____

Measure width of window in 3 places
and circle the narrowest width below:

Width #1: _____

Width #2: _____

Width #3: _____

Measure height of window in 3 places
and circle the longest height below:

Height #1: _____

Height #2: _____

Height #3: _____

For Outside Mount

Width: _____

Height: _____

Ordering

Mount Type: Inside Outside

Ordering Width: _____

Ordering Height: _____

Type of Blind or Shade: _____

Style Name: _____

Color Number: _____

Controls & Options to consider:

Corded

Cordless

Bottom Up/Top Down
(Cellular, Pleated, Roman, and
Natural Shades)

Sun Up/Sun Down
(Cellular & Pleated Shades only)

Cornice: _____

Valance: _____

Other: _____

Window #3 _____
(location)

Measuring

For Inside Mount

Depth of window casing: _____

Measure width of window in 3 places
and circle the narrowest width below:

Width #1: _____

Width #2: _____

Width #3: _____

Measure height of window in 3 places
and circle the longest height below:

Height #1: _____

Height #2: _____

Height #3: _____

For Outside Mount

Width: _____

Height: _____

Ordering

Mount Type: Inside Outside

Ordering Width: _____

Ordering Height: _____

Type of Blind or Shade: _____

Style Name: _____

Color Number: _____

Controls & Options to consider:

Corded

Cordless

Bottom Up/Top Down
(Cellular, Pleated, Roman, and
Natural Shades)

Sun Up/Sun Down
(Cellular & Pleated Shades only)

Cornice: _____

Valance: _____

Other: _____